



උව පළාත් අධ්‍යාපන දෙපාර්තමේන්තුව
 ංඞඞා ඞාකාං කල්ඞිත ත්‍රිංංකකංඞාඞ
 Uva Provincial Department of Education
 PRACTICE TEST - 2021 (2022)



Grade 11

Science - I

Time :1 hour

Name / Index No. :

- Answer all questions.
- In each of the questions 1 to 40, pick one of the alternatives (1), (2), (3), (4) which you consider as correct or most appropriate.
- Mark a (x) on the number corresponding to your choice in the answer sheet provided.

1) Select the answer with homeothermic animals

1. Dolphin and shark 2. Parrot and shark 3. Parrot and shark 4. Shark and Bat

2) Standard unit of heat capacity is

1. J kg K 2. Jkg ⁰C⁻¹ 3. J K⁻¹ 4. J kg⁻¹ K⁻¹

3) Select animals with higher biomagnification

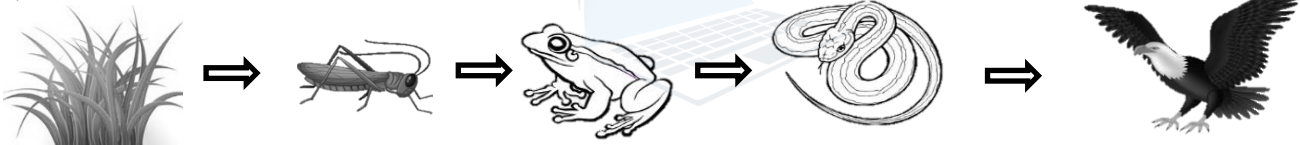

1. Grass 2. Frog 3. Eagle 4. Cobra

4) What are the main components found in LP gas?

1. Propane and butane 2. Octane and butane 3. Methane and propane 4. Hexane and butane

5) Retarded growth of roots and red and purple patches on leaves can be identified on plant leaves due to the deficiency of

1. phosphorus 2. Nitrogen 3. Sulphur 4. Potassium

6) Cells which can be identified only in phloem tissue are

1. Sieve tube elements and vessel elements 3. Sieve tube elements and Companion cells
 2. Vessel elements and companion cells 4. Tracheids and Parenchyma cells

7) Which substance turns phenolphthalein in to pink colour

1. lime juice 2. . Lime water 3. Dilute sulphuric acid 4. Salt solution

8) Which answer indicates elements with the characteristics of metalloids?

1. Na and C 2. B and Al 3. C and Si 4. B and Si

9) Which diagram indicates a system that is not in an equilibrium?

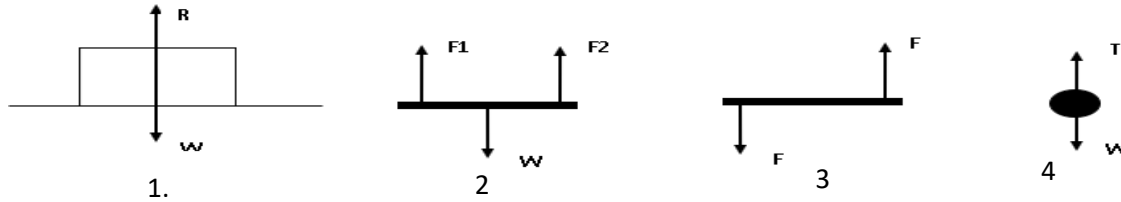

10) Standard symbol for npn transistor is

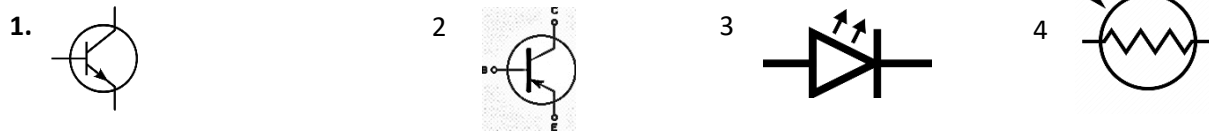

11) Following Punnett square indicates monohybrid cross between homozygous plant for red coloured flowers with heterozygous plant. If red colour is dominant feature, select the genotype ratio for this cross.

1. 1:1:3 2. 2:1:1 3. 1:2 4. cannot be predicted

	R	R
R	RR
r	Rr

12) Sulphate of element X is $X_2(SO_4)_3$. Chemical formula of its oxide is

1. X_3O_2 2. X_2O 3. X_2O_3 4. X_3O

13) The diagram indicates a labourer who works on a construction site. If the weight of labourer is 600N. What is the tension acting on the rope?



1. 800N 2. 200 N 3. 600N

14) This is not a neutralization reaction



15) Several cells found in the human body are given below. Which answer indicates the correct function of the above-mentioned cells?

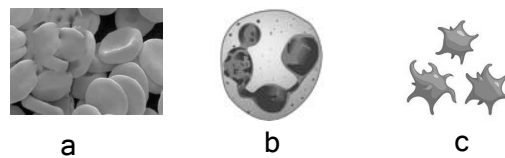

1. Transportation of Oxygen, Blood clotting, Produce antibodies
 2. Blood clotting, Engulf germs, Transportation of Oxygen
 3. Transportation of Oxygen Produce antibodies, Blood clotting
 4. Blood clotting, Transportation of Oxygen Engulf germs

16) A group of students arranged three setups labeled A, B, and C to examine the solubility of sugar. They measured the mass of remaining sugar after a few hours. Which answer indicates ascending order of the mass of remaining sugar?

1. $C > A > B$ 2. $A > B > C$ 3. $B > C > A$ 4. $C > B > A$

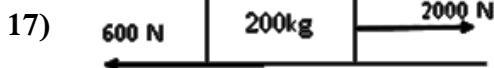
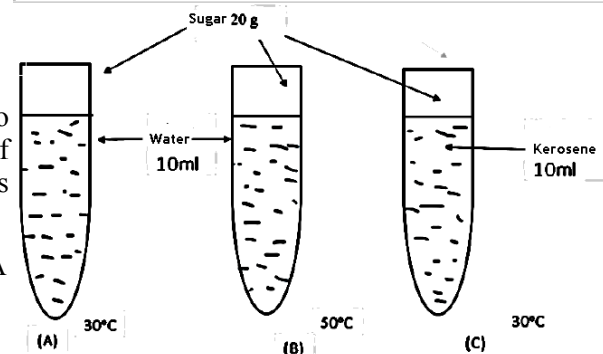

The engine generates 2000N of force on a 200kg vehicle. If the vehicle is exerted 600N of friction from the road, calculate the acceleration of the vehicle.

1. 10 m s^{-2} 2. 7 m s^{-2} 3. 3 m s^{-2} 4. 13 m s^{-2}

26) Formation of basic biological molecules is given below. (X, Y, and Z are basic units of biological molecules)

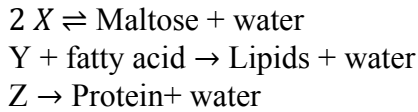

According to the above equations, X, Y, and Z are.

1. Glucose, Fatty acid, Amino acid
2. Glucose, Amino acid, Fatty acid
3. Glycerol, amino acid, Glucose
4. Glucose, Glycerol, Amino acid

27) The following diagram indicates an experiment conducted by a group of students to examine the Archimedes principle.

Which answer indicates the correct value for X and Y readings?

	X	Y
1.	2N	48N
2.	12N	48N
3.	10 N	50N
4.	10N	48N

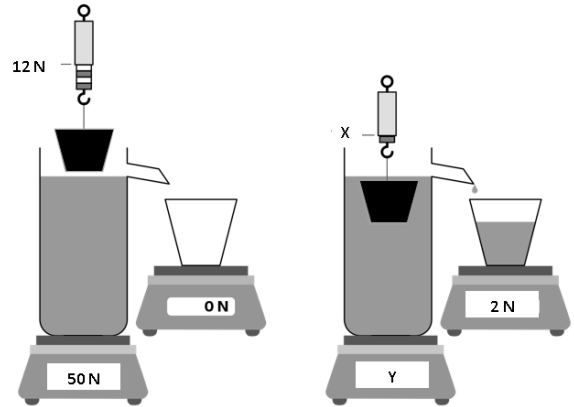

28) The following diagram indicates two types of cell divisions that occur in the living body.

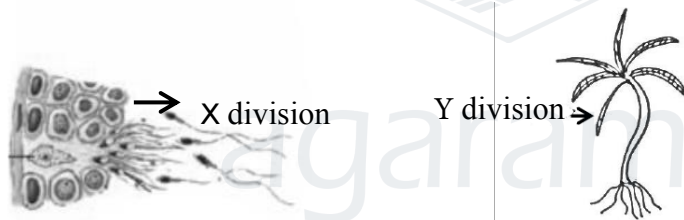

correct statements based on X and Y cell divisions are.

	X division	Y division
1.	receives a constant number of chromosomes	receives half of the chromosomal number of the mother cell
2.	takes place only in diploid cells	takes place in both diploid & haploid cells
3.	daughter cells are similar to mother cell	daughter cells are different from the mother cell
4.	variations do not occur	variations occur

29) Following diagram indicates three methods used to collect gases in school laboratory. What is the correct statement regarding the diagram?

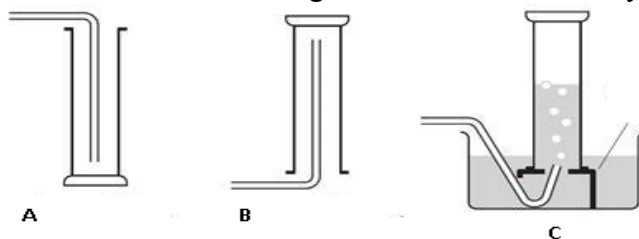

1. A is used to collect CO₂ gas because the density of CO₂ is greater than the density of air
2. B is used to collect H₂ gas because the density of H₂ is greater than the density of air
3. C is used to collect O₂ gas because the density of O₂ is greater than the density of air
4. C is used to collect gases because the solubility of gases in water is high.

30) The following diagram indicates how hormones affect the menstrual cycle of a female.

Which answer depicts the functions of P, Q, and R hormones correctly

1. Ovulation takes place due to the action of the hormone P.
2. Ovulation takes place due to the action of the hormone Q.
3. Menstrual cycle begins due to the action of the hormone R.
4. The wall of the uterus starts to rebuild because of the influence of hormone Q

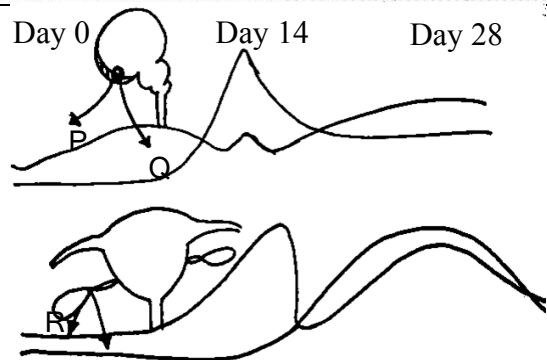

31) Three statements based on the rate of a reaction are given below.

- a. Catalysts are the substances that increase the rate of a reaction by being consumed during the reaction
- b. When the concentration of reactants is increased, the number of collisions of reactants per unit time increases
- c. The rate of reactions increases when the surface area of the reactants is decreased

Correct statements are,

1. a only
2. b only
3. a and b only
4. all above

32) Calculate the hydrostatic pressure that occurs in a 20m deep fresh water pond?

(Density of water = 1000 kg m^{-3} , $g = 10 \text{ ms}^{-2}$)

1. 200000 Pa
2. 200 Pa
3. 2000 Pa
4. 20 Pa

33) The following diagram indicates three unicellular organisms. Which answer depicts their locomotive appendages in order



1.	pseudophodia	flagella	cilia
2.	flagella	cilia	pseudophodia
3.	cilia	flagella	pseudophodia
4.	pseudophodia	cilia	cilia

34) The velocity of an object is changed from 4 m s^{-1} to 12 m s^{-1} within 4 seconds. Calculate the displacement done by the object during this motion.

1. 64m
2. 194m
3. 16m
4. 32m

35) The following diagram indicates a starch test done on the leaf P in a plant that is well exposed to sunlight after keeping it for 48 hours in a dark place. Correct observation is

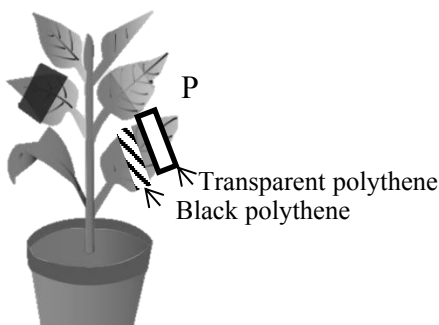

- 1.
- 2.
- 3.
- 4.

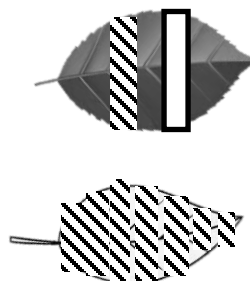
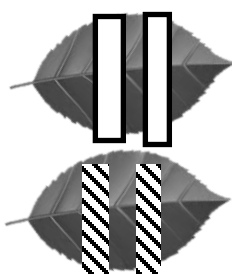

□ purplish blue
▨ light brown

36) Select the incorrect statement about the lattice of a compound

1. Na⁺ and Cl⁻ ions form an irregular three-dimensional array giving rise to an 'ionic lattice
2. Graphite consists of layers of carbon atoms formed by the joining of one carbon atom with three other carbon atoms by single covalent bonds
3. A diamond is a three-dimensional atomic lattice in which every carbon atom forms four single bonds with four other carbon atoms.
4. The arrangement of six Na⁺ ions surrounding every Cl⁻ ion and six Cl⁻ ions surrounding every Na⁺ ion. gives rise to the ionic lattice of sodium chloride

37) The following activity is to inquire into the effect of other metals on the corrosion of iron. A few drops of sodium chloride, phenolphthalein, and potassium ferricyanide were added to the Agar jelly in each setup. Which answer explains the observation which can be obtained after three days?

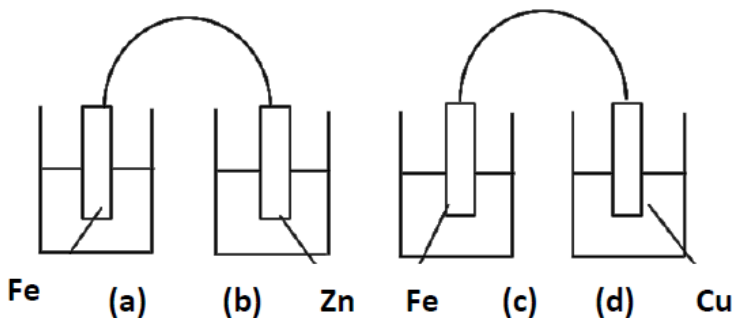

observation				
	setup a	setup b	setup c	setup d
1	pink	no change	blue	pink
2	blue	pink	no change	pink
3	pink	blue	no change	blue
4	no change	blue	pink	blue

38)

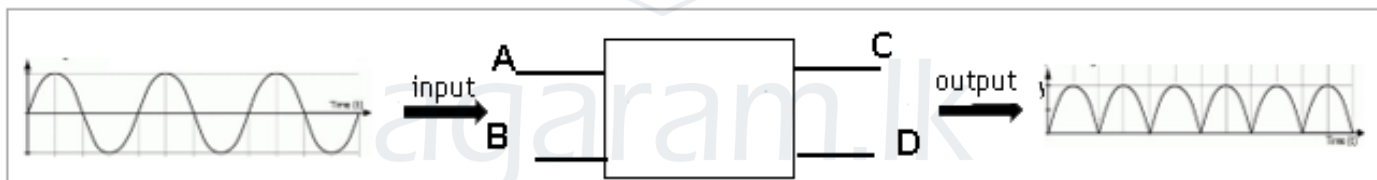

According to the input and output, what is the suitable circuit which should be found in the box?.

- 1.
- 2.
- 3.
- 4.

39) The following are some of the habits that a person follows on a daily basis.

- a. Use of alcohol and tobacco
- b. Avoid foods rich in artificial sweeteners and colourings
- c. Drink enough water (3.5 l – 4.5 l)

Which of the following practices can help prevent cancer?

1. a and b only
2. a and d only
3. b and c only
4. all above

40) The 4 R principle is used in waste management. Which concept in 4R, explains the use of eco-friendly organic fertilizers instead of chemical fertilizers?

1. Reuse
2. Reduce
3. Replace
4. Recycle

උව පළාත් අධ්‍යාපන දෙපාර්තමේන්තුව
ஊவா மாகாண கல்வித் திணைக்களம்
Uva Provincial Department of Education

PRACTICE TEST - 2021 (2022)

Grade 11	Science - II	Time :3 hours
-----------------	---------------------	----------------------

Name / Index No. :

- Answer four questions in part A in the space given.
- Answer only three questions in part B, in separate papers.
- After answering, attach part A and answer script of B together and hand over.

Part A - Structured Essay

1) A. The diagram indicates the situation in which an oil tanker sailing across the Indian Ocean caught fire near Sri Lanka.

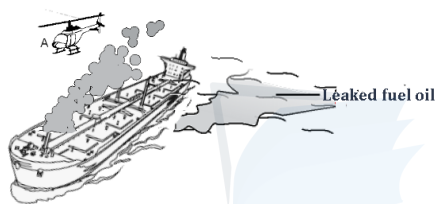

- i. Write down two damages to marine life caused by an oil spill in of oil tanker.
 (02)
- ii. Name two groups of species that are threatened with extinction due to the effect of the floating oil layer.
 (02)
- iii. Name a gaseous compound and particulate matter that may be present in the smoke.
 - a. Gasceous compound b. Particulate matter..... (02)
- iv. Write a direct and indirect effect of this incident on the environment
 - a. Direct effect b Indirect effect.....(02)

B. The chart shows the annual CO₂ emissions of P, Q, R, S countries

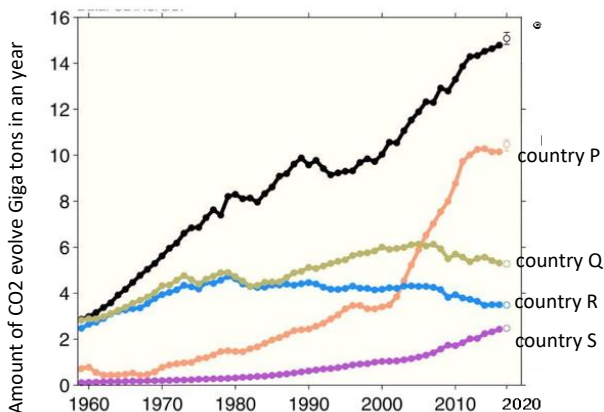

- I. What is the approximate CO₂ emission of R country in 1990?
 (01)
- II. Mention a reason for the increase in CO₂ emissions in country P during the period 2000-2020.
 (01)
- III. Write down 2 steps that those countries might have taken compared to other countries after the year 2000
 (02)
- IV. What is the international convention on reducing the release of CO₂ into the environment?
 (01)
- V. Write down two other gases that get added to the atmosphere except CO₂ due to high fuel combustion
 (02)

Agaram.LK - Keep your dreams alive!

Agaram.LK - Keep your dreams alive!

02) A. Tissue is a group of cells that are specified to perform the specific functions of multicellular animals. Answer the following questions based on the table which provides some animal tissues with their functions

Animal tissues	Function
Epithelial tissue	lining of free Surfaces
P	Providing strength for the organism
Connective tissue	Q
Nervous tissue	transmission of Impulses

- i). Write the most suitable tissues for P and Q
 P:
 Q: (02)
- ii). Write two examples for the tissue mentioned as P.
 (01)
- iii). Write another function of epithelial tissues except the function given in the table
 (01)
- iv). The following incomplete flow chart shows how nerve tissue responds when a thorn pierces the foot. Complete it..

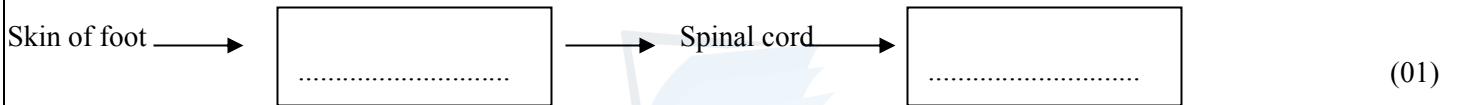

B. The following is a simple setup arranged by a group of students to show that organisms absorb oxygen during respiration.

- i). What is the chemical substance named X?
(01)
- ii). What is the purpose of using X?
(01)
- iii). Draw a control experiment for the above test.

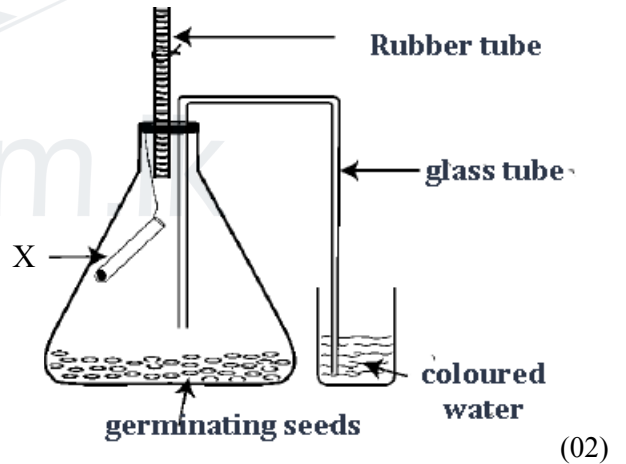
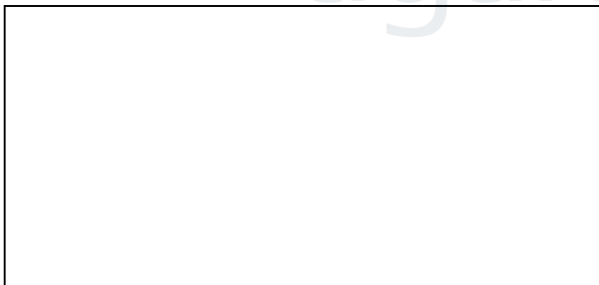

- iv). What is the organelle which conducts cellular respiration in the human body?
 (01)

C. According to modern classification, organisms are classified under three domains..

- I. Achea and Bacteria are two major domains. what is the other domain?
 (01)
- II. What is the domain that is sensitive to antibiotics?
 (01)
- III. Write the animal group that has the following characteristics:
 - a. Penta radial symmetry
 - b. The presence of skin covered with hairs
 - c. The body is segmented externally as well as internally into equal sections (03)

[සියලුම හිමිකම් ඇවිරිණි]
All Rights Reserved]

3. The following graphs show how the first ionization energy and the electronegativity of several consecutive elements in the third period of the periodic table change against the atomic number. The elements are mentioned with nonstandard symbols. The element L is ignited in the air with a blue flame..

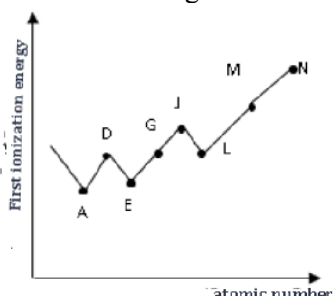

Diagram 01

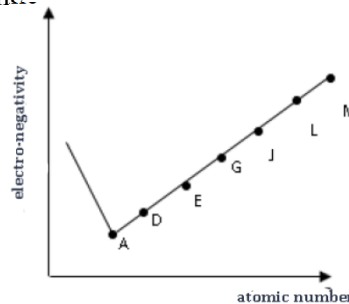
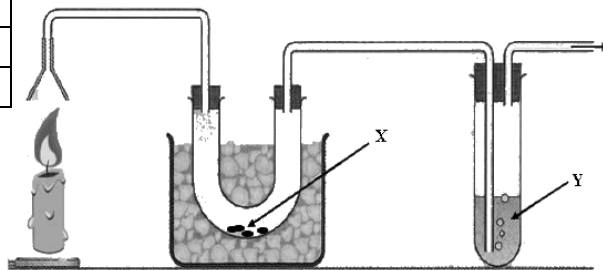

Diagram 02

- i) Define first ionization energy (01)
 - ii) what is the measuring unit used to measure first ionization energy? (01)
 - iii) What is the charge on the atom of an element after the first ionization energy is applied? (01)
 - iv) What is the reason for the first ionization energy of element A being lower than other elements? (01)
 - v) Write the balanced chemical equation for the reaction of element D with steam. (01)
 - vi) What type of chemical reaction does the above reaction belong to? (01)
- B)
- i) Write the chemical formula of the compound formed due to the reaction between the elements D and m. (01)
 - ii) What is the chemical bond formed here? (01)
 - iii) Name the element that forms amphoteric oxide out of the elements shown here. (01)
 - iv) Element N is not found in the graph given in diagram II. Explain why? (01)
 - v) Draw a diagram to explain the polarization of a molecule formed by element A with Fluorine.. (01)
- C The diagram indicates a test carried out to confirm the C and H contained in a hydrocarbon Complete the table based on this experiment (02)

Substance	Observations that can be seen shortly after lighting the candle
X	
Y	



ii) a. Rubber stoppers are used with U-tube. Underline the monomer of natural rubber out of P and Q. (01)

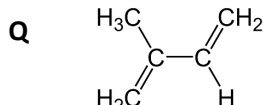
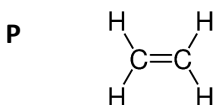

b. Draw the structure of the natural rubber. (01)

4. A. The diagram indicates a set-up prepared by a group of students to examine linear motion on a table with a rough surface.
The magnitude of the load is changed by using a set of masses.

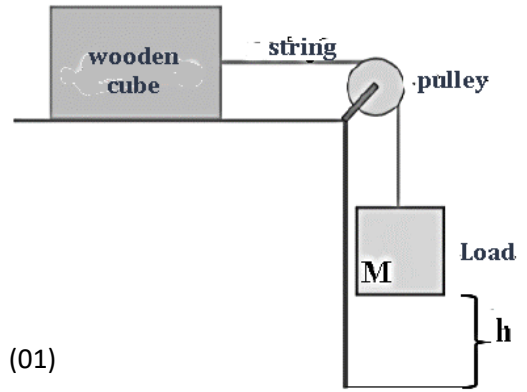

I. Although the load was applied, at first, it was observed that the block does not move.
What is the reason for it?

..... (01)

II. One force that acts on the object is given in the diagram. Mark other forces acting on it.

(02)



III. As the load increases, the object begins to move at a certain point. At this situation object moves with

- a) Uniform velocity. b) uniform deceleration c) uniform acceleration

Underline the correct answer above.

(01)

IV. A.) Write a change that needs to be made to the table to allow the object to move forward with a small load.

..... (01)

B.) What is the use of the pulley in this activity?

..... (01)

B. 10 N of force is applied to the 200 g of the block of wood which is placed on a smooth surface..

I. The wooden cube was moved 25 cm along the surface. The amount of work done is =X
= (03)

II. Write an expression to calculate the amount of energy stored in a load located at a certain height using m and h.
..... (01)

IV. write a way that can be used to stop the acceleration of the wooden block
..... (01)

V. Calculate acceleration of above motion
.....
.....
..... (01)

VI. If above mentioned, work done in two seconds, calculate power by filling in the blanks given below .

$$\text{Power} = \frac{\dots\dots\dots}{\text{time}}$$

$$= \frac{\dots\dots\dots}{2 \text{ s}}$$

$$= \dots\dots\dots (03)$$

Agaram.LK - Keep your dreams alive!

Agaram.LK - Keep your dreams alive!

Part B - Essay

05)

A. The process by which the body adapts to changes in the internal and external environment. is called Coordination

i). There are two systems that contribute to human coordination. One is the nervous system . Name the other system. (01)

ii). The diagram showing the external appearance of the human brain

- a. What is the covering layer which protects the human brain? (01) X
- b. Write another function of the membrane mentioned above. (01)
- c. Label the parts mentioned as X and Y (02)
- d. Write the function of Y. (01)

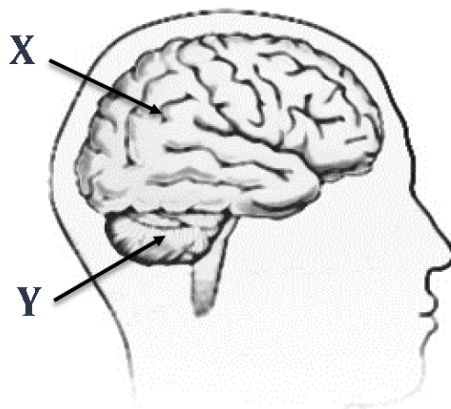

iii).
a. What is the functional unit of the nervous system? (01)
b. Write an example for a cranial reflex action (01)

B. Human is a homeothermic animal.

- i).
a. Define homeothermic animal. (01)
- b. Write another group of homeothermic animals except mammalia. (01)
- c. What is the temperature-controlling center of the human body? (01)
- d. Write two changes that take place in the human body to maintain a constant temperature when the temperature of the external environment decreases. (02)
- ii).
a. Name the hormone that controls the rate of metabolism in the human body. (01)
- b. What is the endocrine gland that produces the hormone mentioned above? (01)
- c. Write two special features of hormones. (01)

C. The flower is the reproductive organ of a plant. The following diagram indicates the androecium and gynoecium of a flower.

- i). Label A, B, C, and D mentioned above (02)
- ii). Explain fertilization using the letters mentioned above (01)
- iii). "Fruits like grapes and apples do not have seeds." Explain scientifically (01)

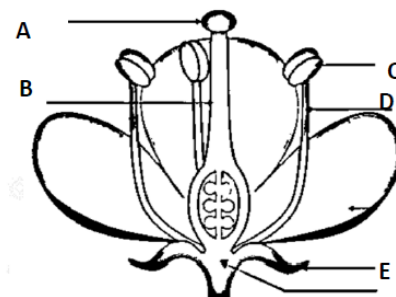

06) The following diagrams indicate some of the methods used to separate and identify the components of different mixtures.

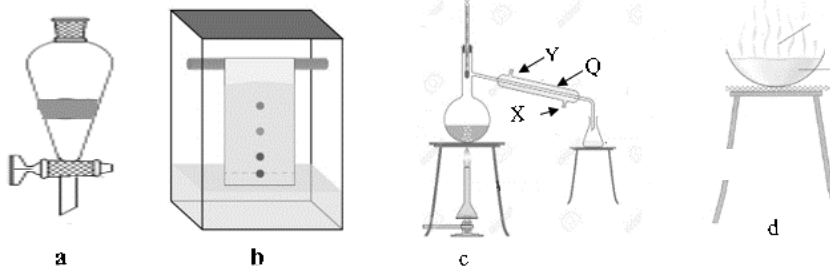

- i). Write the relevant letter according to the separation technique given below. (04)
a. Identification of the pigments in a food.
b. Extraction of iodine from aqueous iodine
c. Obtaining distilled water from seawater.
d. Extraction of crystals from aqueous solution
- ii) Label the apparatus a and d mentioned above. (02)
- iii) a) what is the purpose of using equipment Q? (01)
b) From which point does the cold water enter in to Q? (01)
c) Explain your answer. (01)

Agaram.LK - Keep your dreams alive!

Agaram.LK - Keep your dreams alive!

- B) 500 cm^3 of 0.4 mol dm^{-3} of NaOH solution should be prepared.
- Calculate the number of NaOH moles needed to prepare the above solution (02)
 - Calculate the mass of NaOH needed to prepare the above solution (02)
 - How does the temperature change when dissolving NaOH in water? (01)

C) The following setup was prepared by a group of students to examine the rate of reaction .

- Define the rate of a reaction. (01)
- Arrange the above setups according to the ascending order of their rate of reaction.. (01)
- a. This experiment was arranged to examine two factors that affect the rate of reaction. .
What are those two factors? (02)

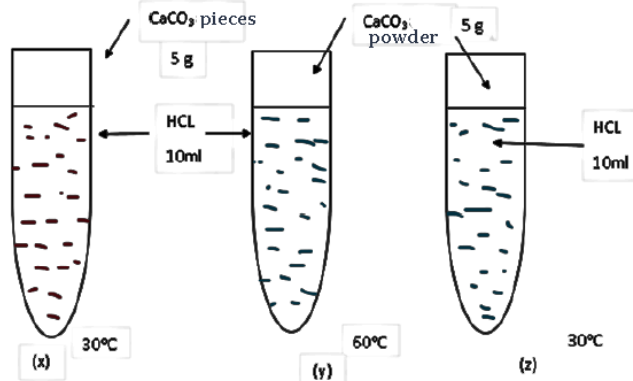

- b. Write a possible strategy to maintain the temperature of the above setup at 60°C . (01)
- c. Write the balanced chemical equation for the above reaction. (01)

07). This diagram shows how electricity is supplied to the house from the national grid.

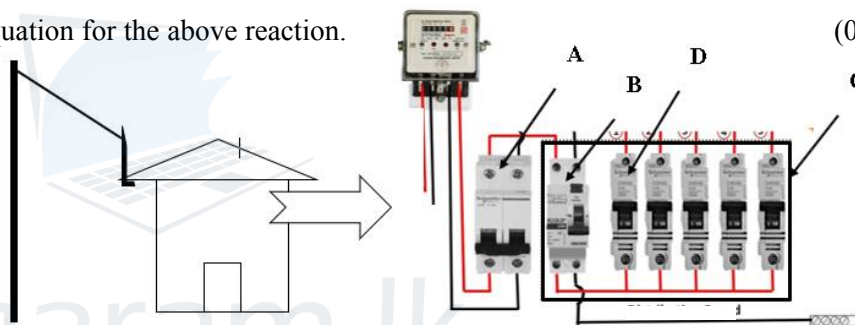

- a) Write the voltage and frequency of the electricity coming to the house from the national grid. (02)
- ii) Name the A, B, D nodes in the household circuit. (03)
- iii) a) What is the device that works, when the magnitude of the current flowing through the household circuit increases to a certain number?. (01)
- iv) b) In addition to the two wires above, there is another wire that should be in the household circuit. What is it? (01)

B) In addition to the two wires above, there is another wire that should be in the household circuit.

- i) What is it? Write down the energy conversion that takes place here. (01)
- ii) Write down 2 physical properties that the heating coil must have? (02)
- iii) This device has a switch to turn it off automatically. Write down the advantage of it. (01)
- iii) The water is expected to heat up by sending 6A of electric current with 240V of potential difference.
 - Calculate the power of the heating coil. (02)
 - Write the methods of heat transfer in the following situations. (02)
 - Heating the Nichrome coil
 - Heat transfer in water

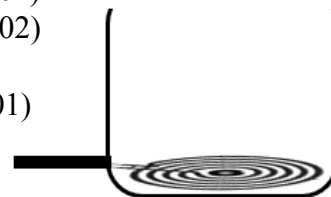

C) A student explained that heat loss as radiation from this device is a disadvantage.

- i) To what type of wave that thermal radiation belong? (01)
- ii) Write 02 common properties of above mentioned waves. (02)
- iii) Write a way to minimize the heat loss caused by the above-mentioned method. (02)

08) A. Inherited characteristics are very important to distinguish one species from another.

- i). Write an Inherited characteristic that is commonly seen in humans, and a characteristic that is rarely seen in humans (02)
- ii). The ratio of males to females in a human race is 1: 1. Explain human sex determination based on the genetic flow diagram (03)
- iii). The following is an incomplete diagram of human genetic disorders..

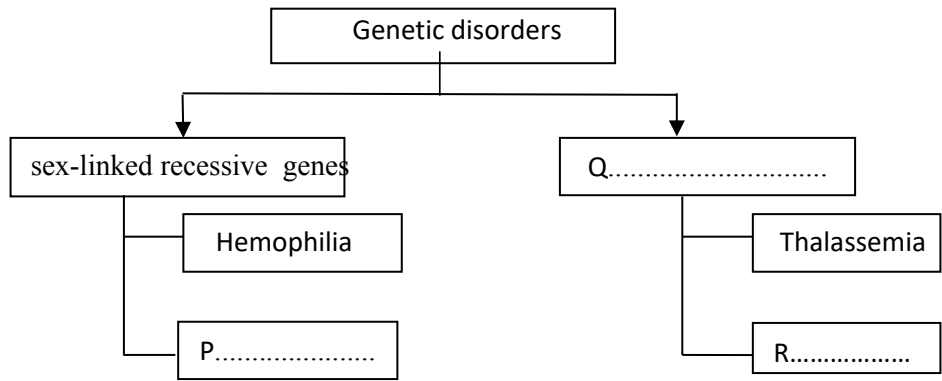

- a. Label P,Q and R . (03)
- b. What are the symptoms of hemophilia patient? (01)
- c. What is the reason for genetic disorder R? (01)

B.) Figure I shows a magnetic field around a current-carrying conductor. Figure II shows a movable conductor placed in a magnetic field.

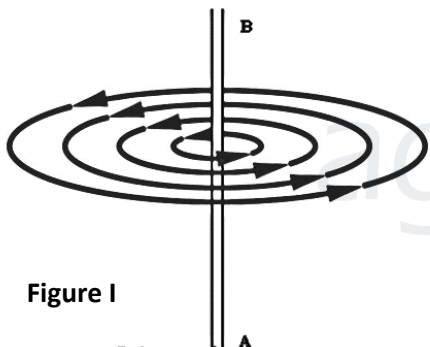

Figure I

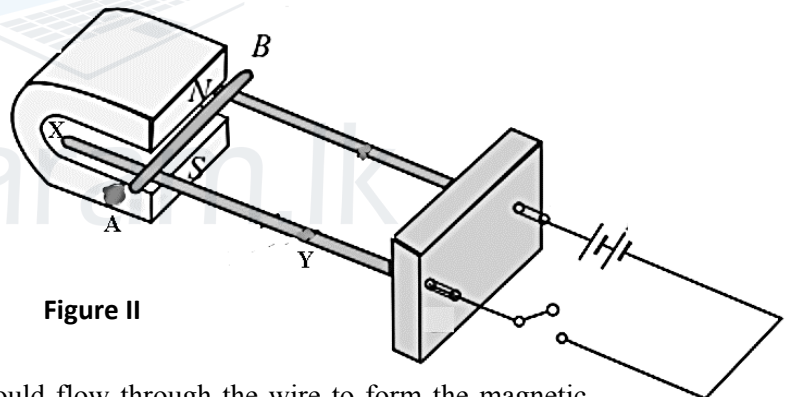

Figure II

- i).
 - a. What is the direction in which the current should flow through the wire to form the magnetic field as shown in Figure I? (01)
 - b. Which rule do you use to determine the direction of the current in figure I above? (01)
- ii).
 - a. In Figure II, what is the direction of current flow when the switch is closed? (01)
 - b. What is the direction of the movement of A B rod based on x and y? (01)
 - c. Write down two strategies that can be used to increase the speed of the motion of the AB rod. (02)

C) The diagram shows how both the primary and the secondary are located in a transformer.

- i). What type of transformer is shown in Figure I? (01)
- ii). If the number of turns in the primary coil and the secondary coil of that transformer are 100 and 1000, respectively, find the output voltage at the end of the CD (02)
- iii). Write use of the transformer shown in Figure II. (02)

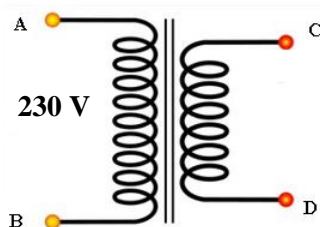

Figure I

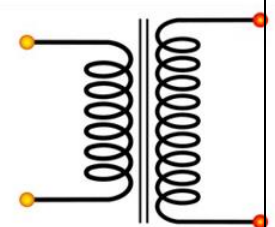
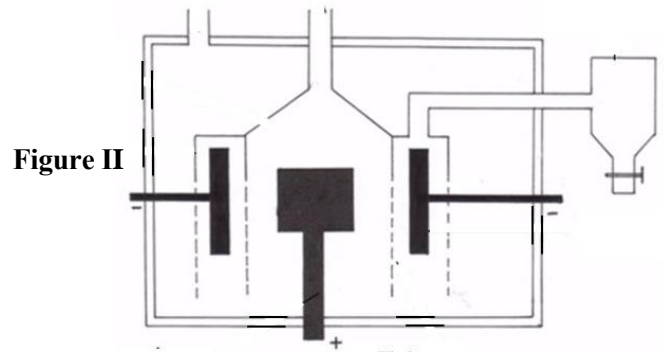
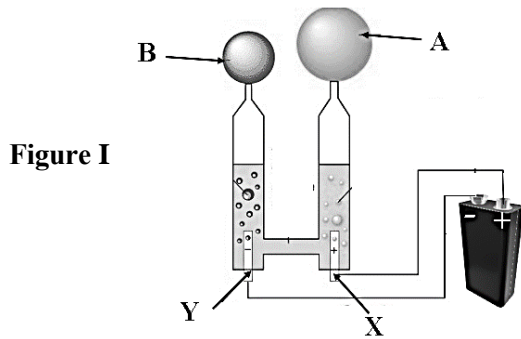

Figure II

09). The figure shows two instances where electrolysis is used.



- A) i) Define electrolysis. (02)
- ii) Figure I shows a setup used to produce the metal Sodium. What is the name of this cell? (01)
- iii) Name the anode and cathode of this cell. (01)
- iv) Write the half reaction that occurs near the anode. (02)
- v) What is the purpose of using CaCl_2 as the raw material for this process? (01)
- vi) a. What are the gases collected to the A and B tubes? (01)
- b. How to identify the gas collected in B in the laboratory? (01)
- c. Draw the Lewis structure of the gas collected at A? (01)

B) The transmission of light rays emitted by a bulb in the bottom of a fish tank is shown in Figure I, and the transmission of a ray in optical fiber is shown in Figure. II. The critical angle of water is 49°

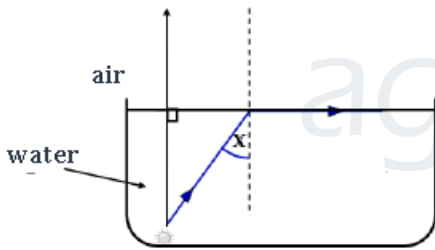

Figure I

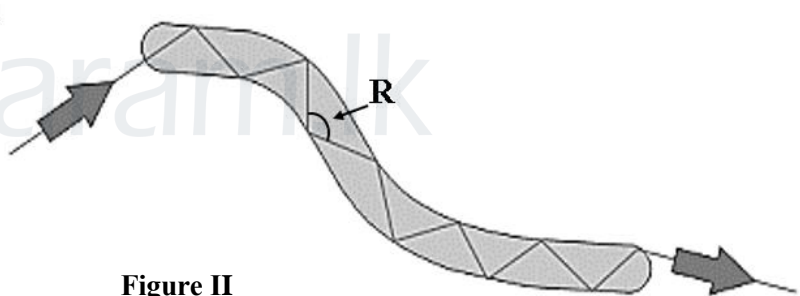
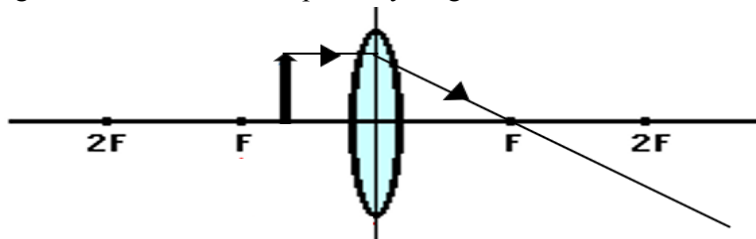

Figure II

- i) Write the letter/letters that represent the critical angle from the I and II diagrams.. (01)
- ii) What is the phenomenon shown by Figure II? (01)
- iii) Write the factor that should be fulfilled to happen the phenomenon in Figure II. (01)

C) The following diagram indicates an incomplete ray diagram drawn for use in a convex lens.



- i) Copy the above ray diagram on your answer sheet and complete it. (03)
- ii) Write down the 02 properties of the image formed above. (01)
- iii) Write a use of the above instance. (01)
- iv) Explain how this lens should be used in the above situations to get clearer images (02)

Third Term Test -Uva province 2022(2021)

Garde 11 - Science – Answer script

Part I-

Question No	Answer	Question No	Answer	Question No	Answer	Question No	Correct Answer
1	2	11	2	21	3	31	2
2	3	12	3	22	2	32	3
3	3	13	1	23	1	33	1
4	1	14	4	24	4	34	4
5	1	15	3	25	4	35	4
6	3	16	4	26	4	36	2
7	2	17	2	27	3	37	1
8	4	18	2	28	2	38	4
9	3	19	4	29	1	39	3
10	1	20	4	30	2	40	3

Part II

Part A (Structured essay)

1. A

- i. Breathing difficulties for fish/deposition of oil in the digestive system of animals/ deposition of oil in the gills of fish/ reducing the rate of photosynthesis due to reduction of transparency of seawater (02 marks)
- ii. Fish, Turtles (02 marks)
- iii. a. SO₂ /CO₂/ CO b. carbon powder (1x2=2 marks)
- iv. a. acid rains / Global warming b. reduction of biodiversity / reduction of efficiency of aquatic plants (1x 2=2 marks)

B

- i. 2 gigatons (unit is compulsory) (01 mark)
- ii. Growth of population/ increase the needs of humans/ industrialization (01 mark)
- iii. Using green concept / increase the usage of renewable energy sources/ reduction of combustion of fuels (02 marks)
- iv. Kiyoto convention (01 mark)
- v. NO₂ / CO / SO₂ (02 marks)

2. A.

- i. P – muscle tissue (01 mark)
 - Q- maintains the connection between organs and tissues (blood/ bones/ cartilage) (01 mark)
 - ii. Skeletal muscles/ smooth muscles/ cardiac muscles (01 mark)
 - iii. secretions/ absorption/ protection/perception (01 mark)
 - iv. Sensory neuron / motor neuron (01 mark)
- B.
- i. potassium hydroxide (KOH) (01 mark)
 - ii. Conical flask /to absorb carbon dioxide in the vessel (01 mark)

iii. .

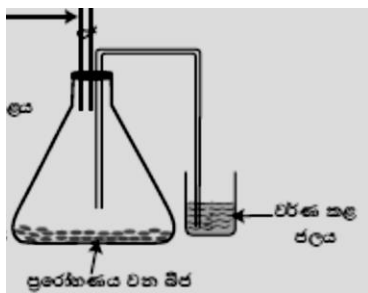

(02 marks)

iv. Mitochondria

(01 mark)

C

i. Domain Eukarya

(01 mark)

ii. Bacteria

(01 mark)

iii. a. Echinodermata

(01 mark)

b. Mammalia

(01 mark)

c. Annelida

(01 mark)

3. A.

i. The first ionization energy of an element is the minimum energy that should be supplied to an atom in the gaseous state to remove an electron to form a unipositive gaseous ion.

(01 mark)

ii. kJ mol^{-1} / kilojoules per mole

(01 mark)

iii. + (positive charge)

(01 mark)

iv. the electron in final energy levels has a low attraction to the nucleus

(01 mark)

v. $\text{D} + \text{H}_2\text{O} \rightarrow \text{DO} + \text{H}_2$

(01 mark)

vi. chemical combination reactions

(01 mark)

B.

i. DM_2

(01 mark)

ii. ionic bond

(01 mark)

iii. E

(01 mark)

iv. low tendency to form chemical bonds / noble elements are not making bonds

(01 mark)

v.

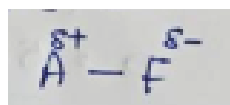

(01 mark)

C.

X - blue

Y - milky

(02 marks)

ii. a. Q

(01 mark)

b.

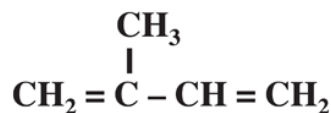

(01 mark)

c. polymers with cross links

(01 mark)

4.

A.

- i. Due to static friction / acts friction similar to applied force (01 mark)

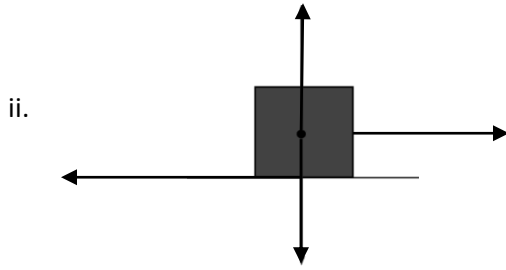

- iii. C / Uniform acceleration (01 mark)

- iv. a. making the surface smooth / apply lubricants / apply grease or oils (01 mark)

- b. can apply the force easily (01 mark)

- B i. Work = Force x distance

$$= 10\text{N} \times 25/100 \text{ m} = 2.5\text{J} \quad (03 \text{ marks})$$

- ii. $E = mgh$ (01 marks)

- iii. $F = ma$ (01 mark)

- iv. $10 = 200/1000 \times a$

$$a = 50 \text{ ms}^{-2} \quad (01 \text{ mark})$$

- v. Power = $2.5\text{J} / 2 \text{ s} = 1.25 \text{ J s}^{-1}$ or 1.25 W (03 marks)

Part B (essay)

5. A

- I. Endocrine system (01 mark)
- II. a. meninges (01 mark)
- b. protect from dehydration / protect from microorganisms/ absorb shocks/ protect form change of temperature (01 mark)
- III. a. Reflex arc (01 mark)
- b. Blinking eyes / sneezing/ salivation (01 mark)

B

- i. a. Organisms who do not change their body temperature based on the environmental temperature (01 mark)
- b. Birds / Aves (01 mark)
- c. Hypothalamus
- d. Shivering / erect hair/ reduction of sweat formation/ contraction of blood capillaries in the skin (01mark)
- ii. a. Thyroxin (01 mark)
- b. Thyroid (01 mark)
- c. acts on target organs/ produced in endocrine glands/ transport through blood/Organic substances/ acts with low concentration (01 mark)
- C. i. a. stigma b. style c. Anther d. Filament (02 marks)
- ii. Pollen grains in C deposit on A. Pollen tube grows through B and fuses with ovules. (01 mark)
- ii. Fruit was formed without fertilization. So seeds are not formed (01 mark)

6. A

- i. a → b
 b → a
 c → c
 d → d

(01 x4 = 4 marks)

- iii. a. separating funnel
 b. Liebig condenser

(02 marks)

- iii. a. Condense the vapour and convert in to liquid
 b. X

(01 mark)

(01 mark)

- c. Liebig condenser filled with water. So vapour get condense quickly

(02 marks)

- B. i. $C = n / v$ $0.4 = n / 0.5$ $= 0.2 \text{ mol}$

(02 marks)

- ii. $n = m / M$ $0.2 = m / 40 \text{ g mol}^{-1}$ $= 8 \text{ g}$

(02 marks)

- iv. evolve heat. / exothermic

(01 mark)

- C. i. the amount of change occurred in unit time / Rate of reaction = Amount of reactants used up/ Time taken

(01 mark)

- ii. $x < Z < Y$

(01 mark)

- iii. Surface area of reactants, Temperature at which the reaction occurs

(02 marks)

- v. Place the test tube in an ice bath from time to time

(01 mark)

7. A

- i. 230V, 50Hz

(02 marks)

- ii. A- Isolator / Main switch

(01 mark)

- B – Residual current circuit breaker

(01 mark)

- D - miniature circuit breakers

(01 mark)

- iii. a. D

(01 mark)

- b. Earth wire

(01 mark)

- earthing the electric current during electric leakage

(01 mark)

- B. i. electrical energy → heat energy

(01 mark)

- ii. High melting point, high resistance

(02 marks)

- iii. Avoid over heating

(01 mark)

- iv. a $P = V I$ = $240 \times 6 = 1440 \text{ W (J s}^{-1}\text{)}$

(02 marks)

- b. i. Conduction

- ii. Convection

(02 marks)

- C. i. Electro-magnetic waves

(01 marks)

- ii. does not need aa medium for propagation/ velocity in vacuum or in air is $3 \times 10^8 \text{ ms}^{-1}$

(02 marks)

- iii. polish the outer surface.

(01 marks)

08.

- A. i. Ability to fold the tongue / - Straight and curved thumb / Curly and straight hair / Skin colour (01 mark)
 ii. ratio between male and female is 1 :1 (03 marks)

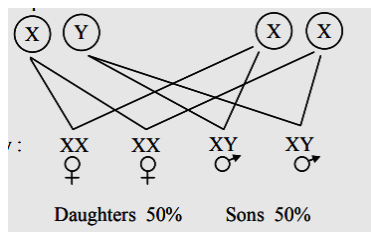

- iii. P. colour blindness (01 mark)
 Q. Genes/ mutations of genes (01 mark)
 R. albinism (01 mark)

b. blood does not clot while bleeding. (01 mark)

B.

- i. a. A to B (01 mark)
 b. Amperes' right hand rule / Maxwells' cork screw rule (01 mark)
 ii. a. B to A (01 mark)
 b. to Y / X to Y (01 mark)

c. The magnitude of the current through the conductor/The length of the conductor between the rods /The strength of the magnetic field (02 marks)

C. i. Step down transformer (01 mark)

ii. $N_p/N_s = V_p/V_s$ $1000/100 = 230/V_s$ $V_s = 23 V$ (02 marks)

iii. in power stations (02 marks)

9. A

i. The chemical changes brought about by passing electricity through a solution/liquid (01 mark)

ii. Downs' cell (01 mark)

iii. anode - Graphite Cathode - Steel (01 mark)



v. fuse the raw material under low temperature (01 mark)

vi. a. X - O_2 gas / Y - H_2 gas (01 mark)

b. when introducing burning splint, the gas burns with "POP" sound (01 mark)

c. . (02 marks)

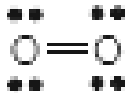

B.

i. X (01 mark)

ii. Total internal reflection (01 mark)

iii. Refraction of light from dense medium to rare medium. / Angle of incidence is greater than the critical angle (01 mark)

C. i.

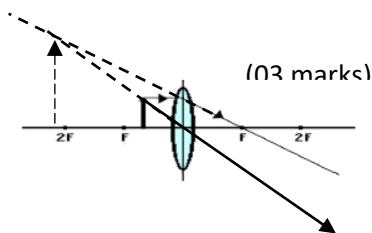

ii. Upright/ Virtual(cannot be taken to a screen)/ Magnified (greater than object) (01 mark)

iii. Magnifying small object by using hand lens (01 mark)

iv. Adjust properly until receiving a clear image.. (02 marks)



LOL.Ik
Learn Ordinary Level

විභාග ඉලක්ක පහසුවෙන් ජයගන්න පසුගිය විභාග පුස්තක පත්‍ර



Agaram.LK - Keep your dreams alive!

Agaram.LK - Keep your dreams alive!

• Past Papers • Model Papers • Resource Books
for G.C.E O/L and A/L Exams



විභාග ඉලක්ක ජයගන්න
Knowledge Bank



Master Guide

WWW.LOL.LK



CASH ON DELIVERY

Whatsapp contact
+94 71 777 4440

Website
www.lol.lk

 **Order via WhatsApp**

071 777 4440